

Cosmo 50

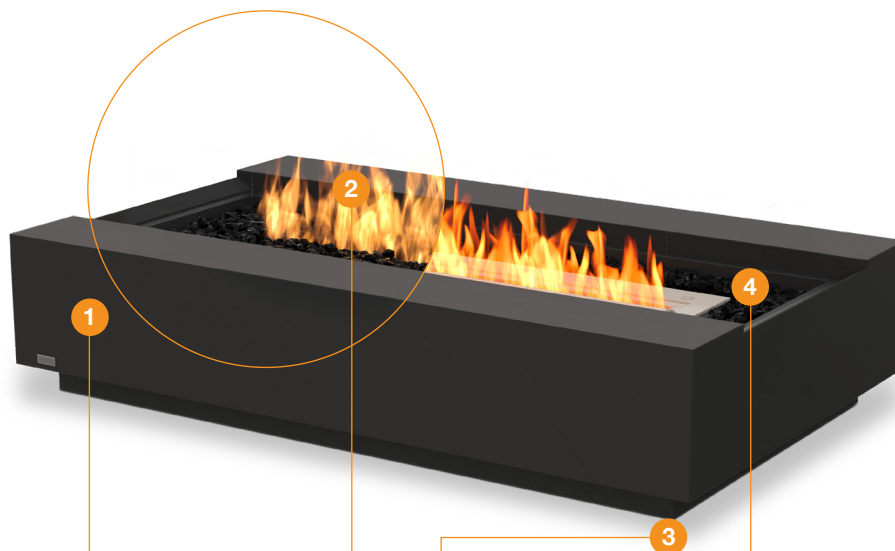

Cosmo 50 Design features



1. Fluid™ Concrete Finish

Incredibly strong yet relatively lightweight, EcoSmart's concrete products incorporate revolutionary Fluid Concrete Technology. Fluid features a stain and impact-resistant barrier that protects the concrete from environmental weathering – even under extreme conditions and long UV exposure.

Premium Teak Wood Finish

The most premium wood on the planet, teak is the strongest, most durable hardwood available. It contains a natural oil which repels water, keeping it from warping, cracking, or becoming brittle. Teak is the perfect material for outdoor furniture.

2. Triple Fuel Advantage

Choose between plumbed natural gas, readily available propane, or our eco-friendly bioethanol fuel system.

3. Articulating Feet

Our Fire Pits and Tables feature 360° height-adjustable articulating feet, so you can achieve a perfectly level and stable model before operating the fireplace.

Surround Colours/Finish

Available in three Fluid™ Concrete colours: Natural, Graphite and Bone. Or Natural Teak hardwood.

4. Decorative Media

Models come with black glass charcoal to add the finishing touch. They do not emit any toxic fumes, smoke, or ash.

Relocate with Ease

When you select Bioethanol or Liquid Propane as your fuel source you'll never be tied down! With zero hard utility connections, relocating your fire is a breeze. Entertain on your own terms with EcoSmart Fire.

Ground Fixing Brackets

Models come with fixing brackets for permanently locating into a fixed position.

Global Compliance

This model complies with existing standards in the USA, Europe, UK and Australia. O-TL listed to UL 1370, EN 16647 BSI Certified and ACCC Safety Mandate compliant for bioethanol burners. LP/NG burners are UL/ULC listed to ANSI Z21.97-2017 and CSA 2.41-2017, and Gas Appliance Regulation 2016/426 as it applies to EU (CE) and UK (UKCA).



Natural
(gas model shown)



Graphite
(ethanol model shown)



Bone
(gas model shown)



Teak
(ethanol model shown)

Disclaimer. All product specifications and data are subject to change without notice and believed to be correct at the time of publication. MAD Design Group (MDG), its affiliates, agents, and employees, and all persons acting on its or their behalf (collectively, "MAD Design Group"), disclaim any and all liability for any errors, inaccuracies or incompleteness contained herein or in any other disclosure relating to any product. MDG disclaims any and all liability arising out of the use or application of any product described herein or of any information provided herein to the maximum extent permitted by law. The product specifications do not expand or otherwise modify MDG's terms and conditions of purchase, including but not limited to the warranty expressed therein, which apply to these products. No license, express or implied, by estoppel or otherwise, to any intellectual property rights is granted by this document or by any conduct of MDG. Customers using or selling MDG products not expressly indicated for use in such applications do so entirely at their own risk and agree to fully indemnify MDG for any damages arising or resulting from such use or sale. Please contact authorised personnel from MDG to obtain written terms and conditions regarding products designed for such applications. Images are indicative only.

Cosmo 50 Accessories



Included accessories



Decorative Glass Charcoal

Our Glass Charcoal is made from high-quality tempered glass.



T

Glass Fire Screen

Paired with a glass fire screen, to stabilises the flame in windy conditions.



E

Jerry Can with Safety Spout and e-NRG bottle adaptor

Jerry Can allows safe storing/decanting of e-NRG ethanol. e-NRG adaptor connects the Safety Spout to an e-NRG bottle. *e-NRG not available in all countries.*



E

Lighting Rod & Lighter

The Lighting Rod is designed to safely adjust the slider position on the burner. It is also used for the ignition procedure.



E

XL Baffles

Placed over the internal burner vents, they serve to increase the efficiency of the burner as well as further stabilise the flame.

T Teak models only E Ethanol models only

Optional accessories



Glass Fire Screen

Pair with a glass fire screen, to stabilises the flame in windy conditions.

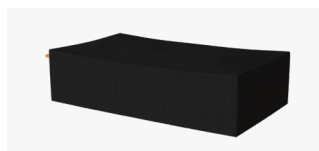

All Seasons Cover

Take care and protect your investment with our stain and water resistant custom outdoor cover.



Silicone Burner Cover

Black silicone burner covers protect burners from the elements when not in use.

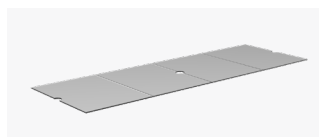

Glass Cover Plate

Enables fire pit tables to easily be transformed into a usable coffee table surface.







Disclaimer. All product specifications and data are subject to change without notice and believed to be correct at the time of publication. MAD Design Group (MDG), its affiliates, agents, and employees, and all persons acting on its or their behalf (collectively, "MAD Design Group"), disclaim any and all liability for any errors, inaccuracies or incompleteness contained herein or in any other disclosure relating to any product. MDG disclaims any and all liability arising out of the use or application of any product described herein or of any information provided herein to the maximum extent permitted by law. The product specifications do not expand or otherwise modify MDG's terms and conditions of purchase, including but not limited to the warranty expressed therein, which apply to these products. No license, express or implied, by estoppel or otherwise, to any intellectual property rights is granted by this document or by any conduct of MDG. Customers using or selling MDG products not expressly indicated for use in such applications do so entirely at their own risk and agree to fully indemnify MDG for any damages arising or resulting from such use or sale. Please contact authorised personnel from MDG to obtain written terms and conditions regarding products designed for such applications. Images are indicative only.

Cosmo 50 Specifications

Sleek and slender, ideal for interiors where space is at a premium, Cosmo 50 enables guests to enjoy the warmth of an open fire without embers, ash and soot.

Ventilation and Efficiency*

Model Dimensions L x W x H mm/in	Compatible Burner	Fuel Capacity	Heats on Average (Indoors)	Thermal Output Net (MAX per burner)	Approx. Burn Time	Minimum Room Size
1270 x 760 x 295 50 x 30 x 11.7	XL900 (Ethanol)	9 L [2.4 Gals]	Over 60 m ² [645 ft ²]	16 MJ/h 15,000 BTU/h, 4.4 kW	8 - 13 hours	110 m ³ [3,884 ft ³]
	Liquid Propane	NA	Outdoor Use Only	65,000 BTU/h, 19 kW	8 - 20 hours	Outdoor Use Only
	Natural Gas				Unlimited	

Application ¹	Indoor & Outdoor
Surround Colours	<ul style="list-style-type: none">  Natural ESF.O.CMO.50.NA ESF.O.CMO.50.NA.G  Graphite ESF.O.CMO.50.GH ESF.O.CMO.50.GH.G  Bone ESF.O.CMO.50.BO ESF.O.CMO.50.BO.G  Teak ESF.O.CMO.50.NF ESF.O.CMO.50.NF.G
Burner Colours	<ul style="list-style-type: none">  Stainless Steel  Black
Materials	Fluid Concrete or Teak Wood Surround, Grade 304 Stainless Steel Burner, with optional Black Ceramic Coating
Approx. Weight	Concr. 68.1kg [149.7lbs] Teak 50.6kg [111.2lbs] Weight includes burner and black glass charcoal.
Fuel Type	e-NRG Bioethanol, Liquid Propane or Natural Gas

*These values are indicative only.

¹ LP/NG is suited for Outdoor use only. Bioethanol is suited for both Indoor/Outdoor use, however, additional parts are REQUIRED for indoor use. Please advise your Sales Representative at the time of purchase so that the product can be configured accordingly. This model complies with existing standards in the USA, Europe, UK and Australia. O-TL listed to UL 1370, EN 16647 BSI Certified and ACCC Safety Mandate compliant for bioethanol burners. **To comply with EN 16647 the Indoor Safety Tray must be installed before operating indoors. LP/NG burners are UL/ULC listed to ANSI Z21.97-2017 and CSA 2.41-2017, and Gas Appliance Regulation 2016/426 as it applies to EU (CE) and UK (UKCA).

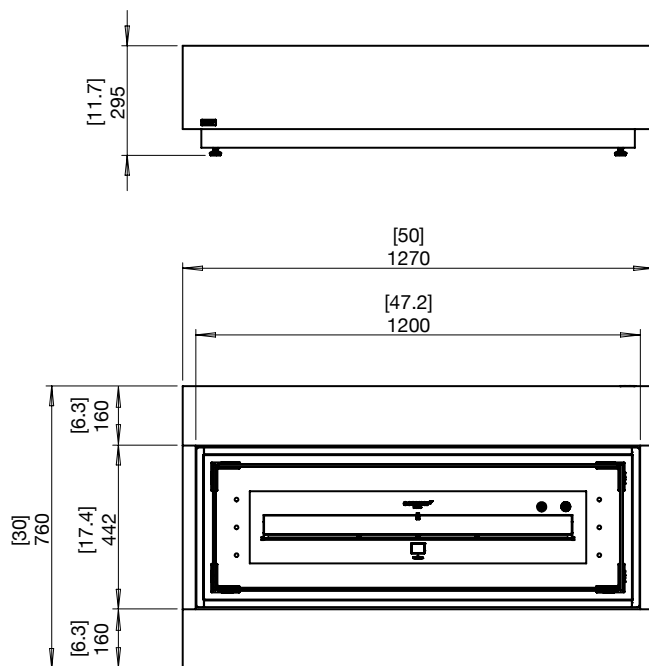

Line drawings show concrete models without a Fire Screen. Refer to the Fire Screen model specifications for dimensions.

FOR MORE INFORMATION PLEASE REFERENCE THE CLEARANCE & INSTALLATION MANUAL

Disclaimer. All product specifications and data are subject to change without notice and believed to be correct at the time of publication. MAD Design Group (MDG), its affiliates, agents, and employees, and all persons acting on its or their behalf (collectively, "MAD Design Group"), disclaim any and all liability for any errors, inaccuracies or incompleteness contained herein or in any other disclosure relating to any product. MDG disclaims any and all liability arising out of the use or application of any product described herein or of any information provided herein to the maximum extent permitted by law. The product specifications do not expand or otherwise modify MDG's terms and conditions of purchase, including but not limited to the warranty expressed therein, which apply to these products. No license, express or implied, by estoppel or otherwise, to any intellectual property rights is granted by this document or by any conduct of MDG. Customers using or selling MDG products not expressly indicated for use in such applications do so entirely at their own risk and agree to fully indemnify MDG for any damages arising or resulting from such use or sale. Please contact authorised personnel from MDG to obtain written terms and conditions regarding products designed for such applications. Images are indicative only.